

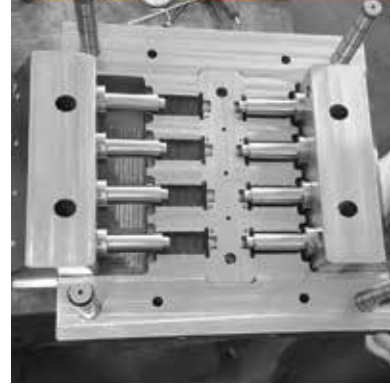

لصناعة قوالب البلاستيك

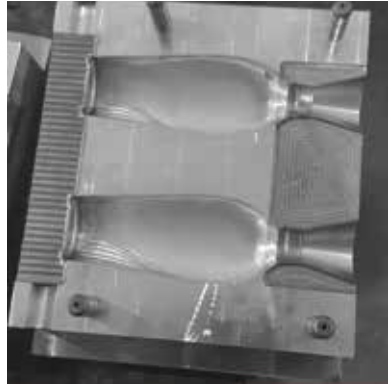

Katalogümüzda ve Web Sitemizde Bulunan Tüm Ürünler Kendi İmalatımızdır.
Ali products in our catalogue and on our website are our own manufacturing.



Küsgel Sanayi Sitesi A Blok
60009 Nolu Cadde No: 6
Şehitkamil / Gaziantep / TÜRKİYE



• 0342 235 64 76
• 0536 990 85 12
• 0536 894 41 19



info@parlakkalip.com



www.parlakkalip.com

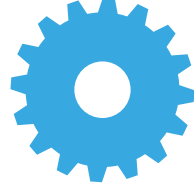

لصناعة قوالب البلاستيك



01

Ürün Katalođu
فهرس المنتجات
Products Catalog



Biz Kimiz?



PARLAK KALIP LTD. ŞTİ.

Parlak Kalıp LTD. ŞTİ. Gaziantep K sget Sanayi B lgesinde 2013 yılının ikinci d neminde kurulmuştur. Kurulduđu g nden bu yana hem yurt ii hem de yurt dıŐı pazarlarında kalitesini kanıtlamıŐtır.

Parlak Kalıp ailesi,  rettiđi  r nler ile m Őteri memnuniyetini en y ksek d zeyde tutmayı ilke edinmiŐ, nitelikli, dinamik ve deneyimli kadrosu ile yol almaya devam etmektedir.

MİSYONUMUZ



GeliŐen teknolojinin hıza uygun makine ve tehzatımızla, uluslararası standartlarda hizmet vermektir.

- M Őteri memnuniyetini her Őeyin  zerinde tutmaktır.
-  retim iin kalite ve m Őteri memnuniyeti ilkesinden taviz vermeden alıŐmaktır.
- Nitelikli, deneyimli, dinamik ve takım ruhuna sahip ekibiyle beklentileri karŐılamak la kalmayıp m kemmeli amalayan  retimi gerekleŐtirmektedir.

VİZYONUMUZ



Yurt ii ve yurt dıŐı t m m Őterilerimize dođru  r n  dođru yere zamanında ve kaliteli teslim sunmaktır.

- Firmamızın sahip olduđu yeri  r n gamımızı arttırarak bu sekt rde  nc  kılmaktır.
- M Őteri memnuniyetini ilke edinmiŐ personelleri ve yetkilileri ile s rekli geliŐmeye odaklanmıŐ  rnek ve lider kuruluŐ olmaktır.
- İnsana ve kuruma saygı erevesinden  d n vermeyen alıŐanlarımızla istihdamımızı arttırmaktır.
- S rekli m Őteri talepleriyle gerek yurt ii gerekse yurt dıŐı pazarlarda aranılan bir marka haline gelmek.

Who we are ?

01

PARLAK KALIP is a manufacturer of precision high-cavitation injection molds that provide trouble-free, high volume production at the lowest total cost of ownership for Fortune 100 customers in the Medical Disposable, Packaging (caps & closures, dispensing apparatus), Pharmaceutical, and Personal Care markets.

Founded in 2013 , PARLAK KALIP has become one of the leading mold manufacturers in G.ANTEP TURKIYE. His vision for Tech Mold was to develop the best, innovative mold solutions for the challenges faced by global OEMs, using the latest machine tool and software technology, and the most talented, creative people.

02

03

Today, Tech Mold has become what KALIP envisioned for the company. Located in three separate facilities, Tech Mold's operations include our R&D Department, our Engineering, Design and Production Mold Manufacturing Operations, and Tech Mold East – our Mold Qualification, Process Validation and Short Run (pre-production) Molding Division.

Our customers have the confidence that a mold designed, developed and qualified by Tech Mold is a mold that will be capable of running anywhere in the world with accuracy, consistency and repeatability

04

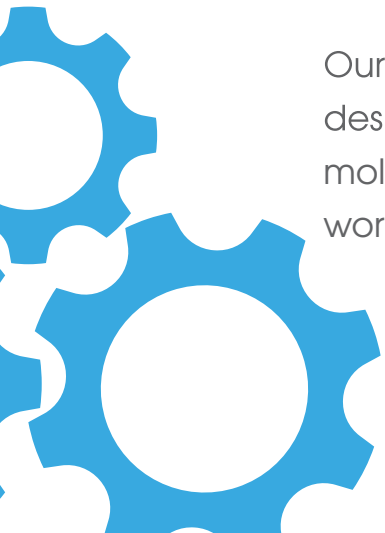

Kristal Kaşık Kalıbı

قالب ملعقة كريستال



Göz Sayısı 25

Adet Ağırlık 1.2 gr.

Malzeme 1.2344

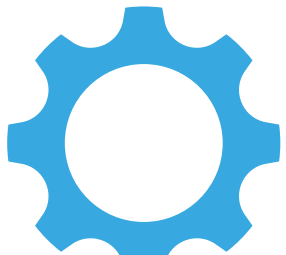
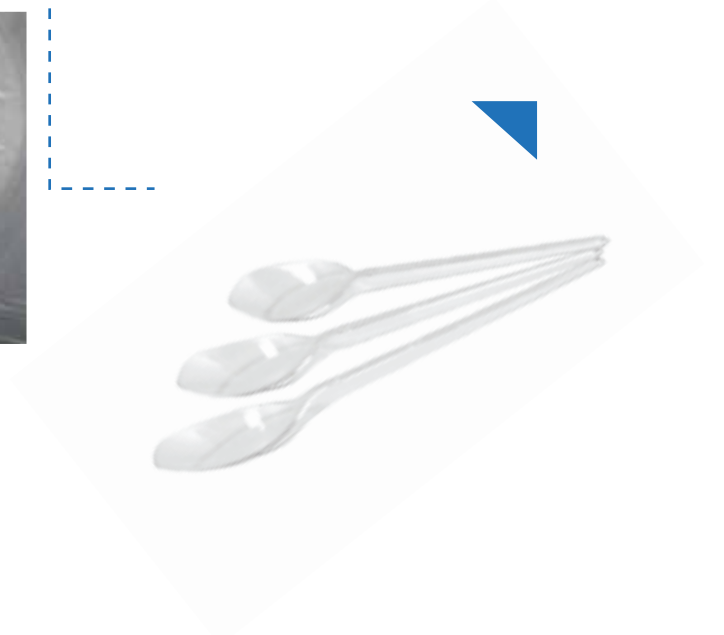

Motorsiklet Motor Kapađı

قالب غطاء محرك دراجة



Göz Sayısı

2

Adet Ađırlık

170 gr.

Malzeme

1.2738



Plastik Civata

قالب صمنة بلاستيك

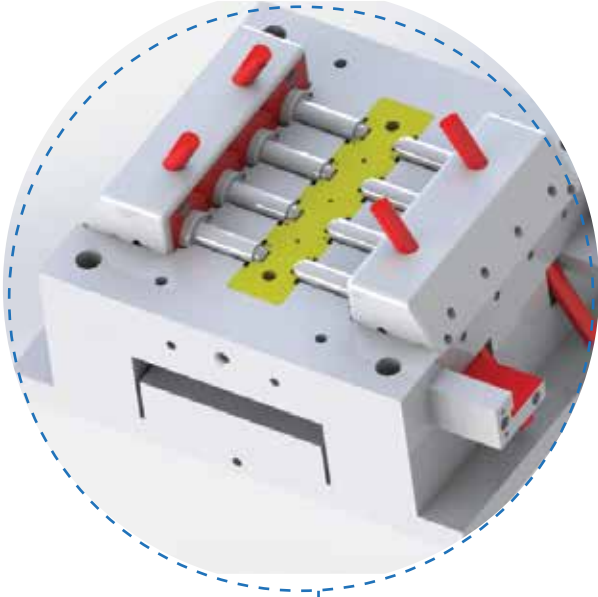

Göz Sayısı

8

Adet Ağırlık

13 gr.

Malzeme

1.2738

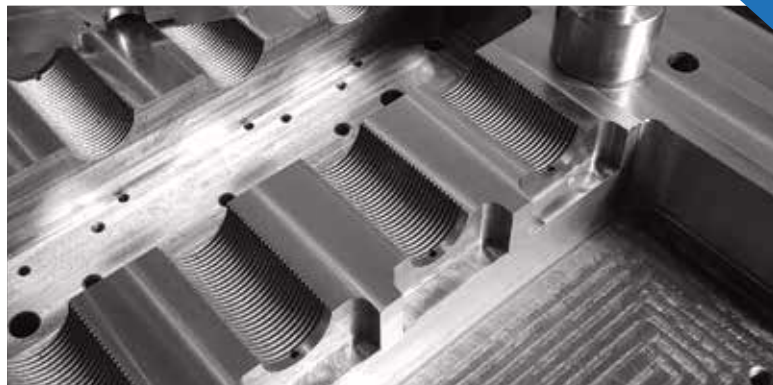
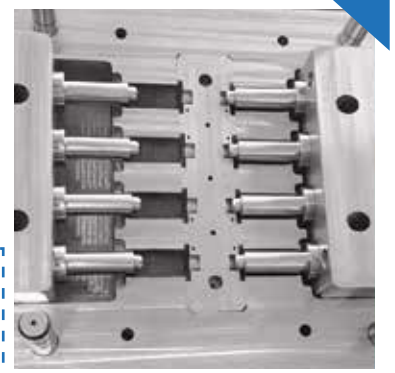

Fan kalıpları

قالب مروحة

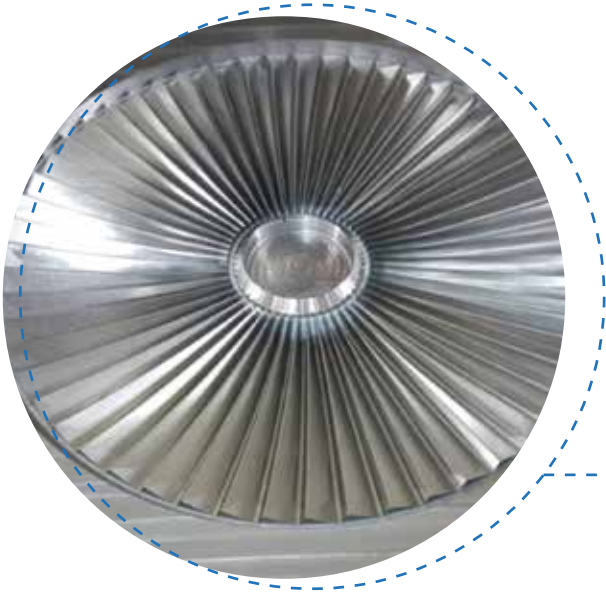

Göz Sayısı

1

Malzeme

1.2738

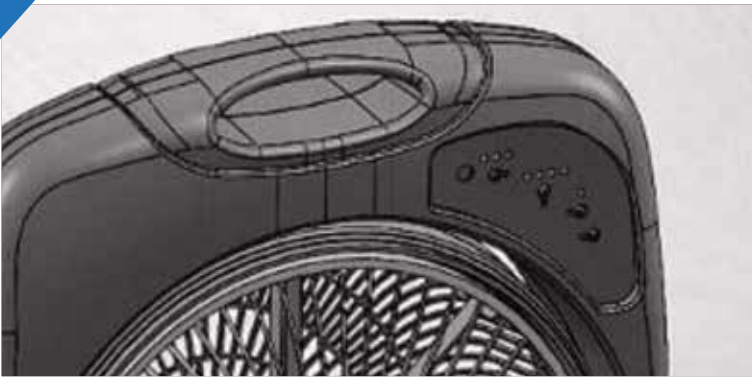

Şampuan Şişirme Kalıbı

قالب نفخ عبوة بلاستيك



Göz Sayısı

4

Adet Ağırlık

60 gr.

Malzeme

1.2738



Su Şişesi Kapağı

قالب غطاء عبوة ماء

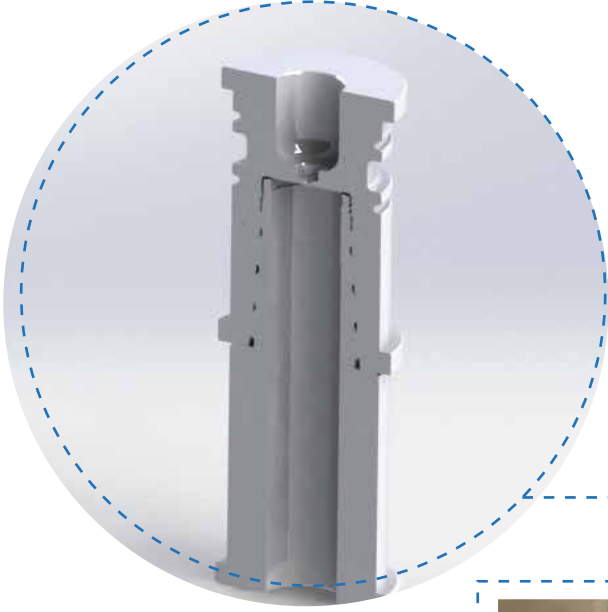

Göz Sayısı

4

Adet Ağırlık

60 gr.

Malzeme

1.2738

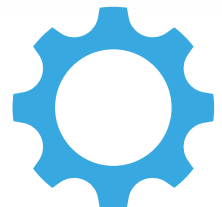

Tavuk iftlięi Su Dolum Tesisatı قالب موزع ماء للمداجن

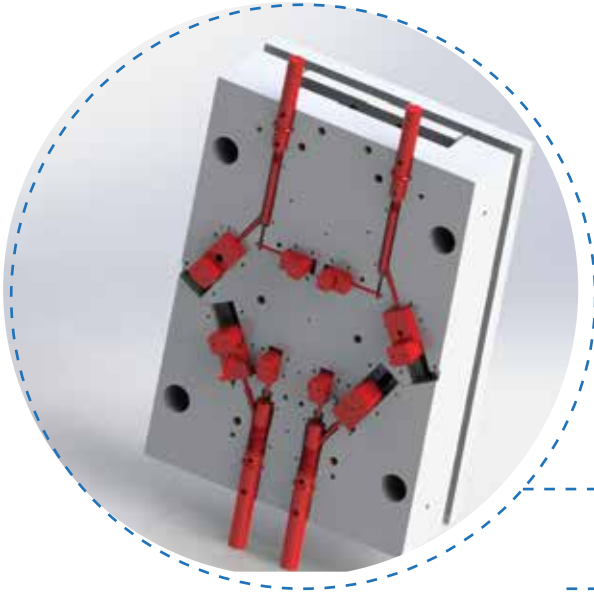

Göz Sayısı

4

Adet Aęırlık

60 gr.

Malzeme

1.2738

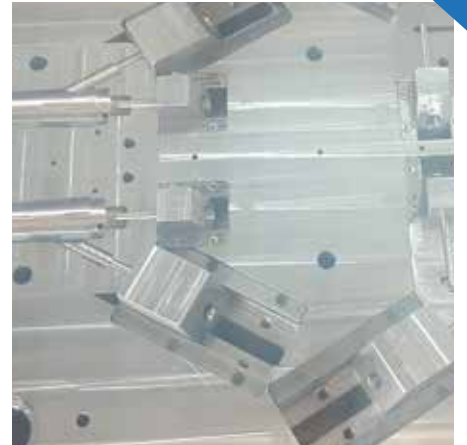

Zirai damlatma kalıbı

قالب نقاط زراعي



Göz Sayısı

4

Adet Ağırlık

1.5 gr.

Malzeme

1.2316

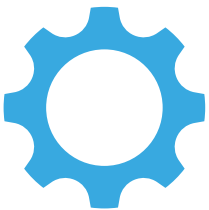
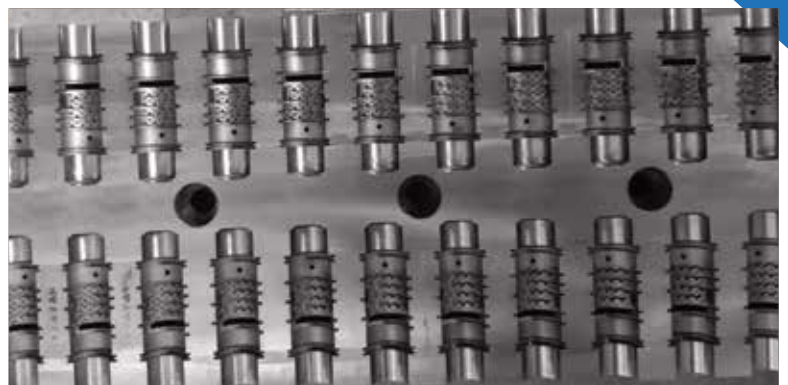
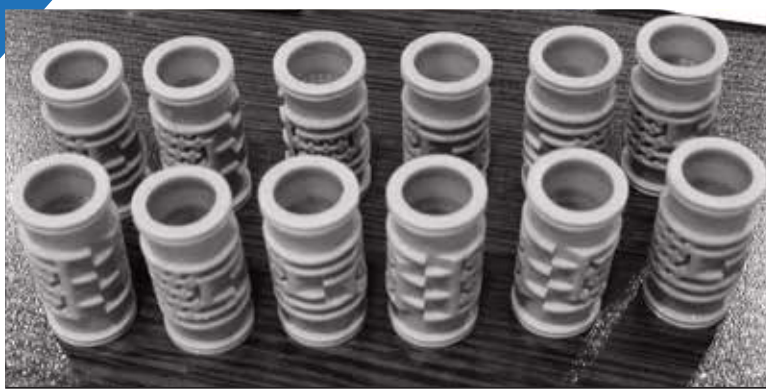

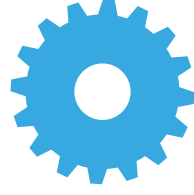

لصناعة قوالب البلاستيك





www.parlakkalip.com



Küsgeç Sanayi Sitesi A Blok
60009 Nolu Cadde No: 6
Şehitkamil / Gaziantep / TÜRKİYE



• 0342 235 64 76
• 0536 990 85 12
• 0536 894 41 19



info@parlakkalip.com



www.parlakkalip.com

**Kataloğumuzda ve Web Sitemizde Bulunan Tüm Ürünler Kendi İmalatımızdır.
All products in our catalogue and on our website are our own manufacturing.**